



BED CURTAINS - Installation guide

BED A - Mid High beds - free height: 75+ cm / Mattress: 160 cm

BED A1 - Mid High beds - free height: 75+ cm / Mattress: 200 cm

BED A2 - Mid High beds corner - free height: 75+ cm / Mattress: 200 cm

A1

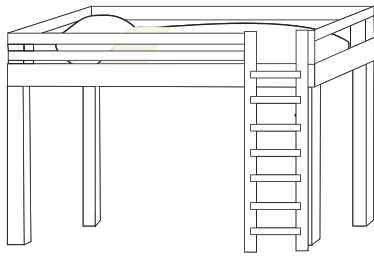

A2

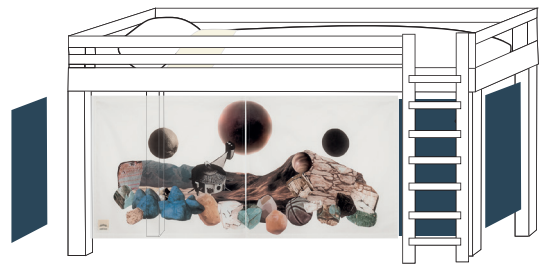
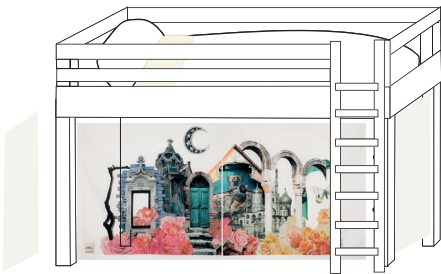
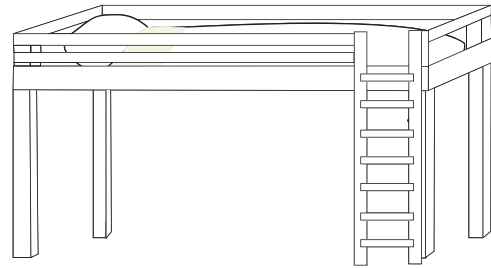

A3

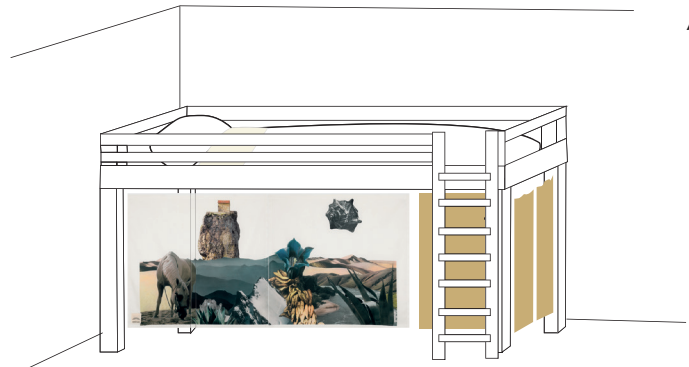

Welcome and thank you for choosing a part of Marooms universe!

This guide helps you install Marooms bed curtains on different kind of beds.

IMPORTANT:

As these are universal bed curtains, for some beds, the bed curtains will reach the bottom of the bed or just to the mattress top.

Make sure to measure the free height before installing.

Made to fit: Flexa classic, Ikea Kura, Ikea Mydal, Hoppekids and Natti mid-high beds.

Mattress length: 160-200 cm.

Marooms curtain height is 75 cm .

The example shows our Fairy tale collage, but the method can be used on all our collages.

Enjoy,
Marooms team

For any questions you might have, kindly contact us at contact@marooms.com.

Content:

2 x printed front curtains with your favorite Marooms collage printed on.

1 x solid colour small front curtain

2 x solid colour side bed curtains

1 x long strap for front bed curtains

2 x shorter straps for side bed curtains

7 x metal hooks

1 x clips to drag the strings through the curtains.

NOTE: to make it easier for screwing the cup screws into the wooden bunk bed, an awl and a hammer is recommended to make the initial holes for the metal hooks.

Warning!

* This is not a toy and not made for children below age 3 years!

* Keep away from fire!

Content:

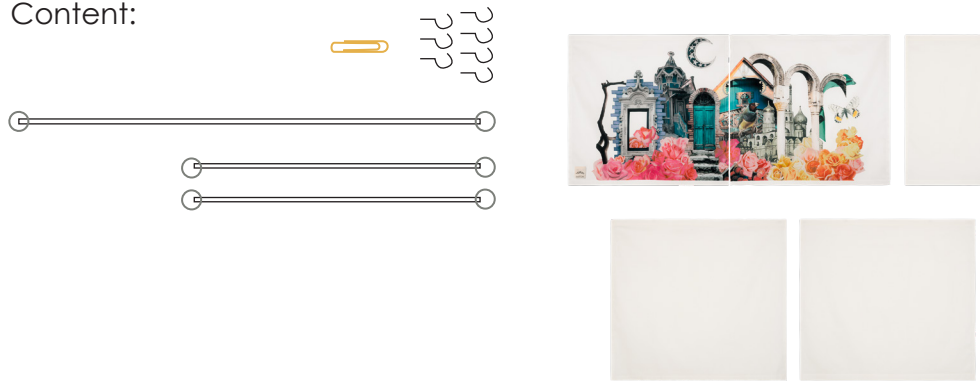

Step 1. put the clips inside the ring.

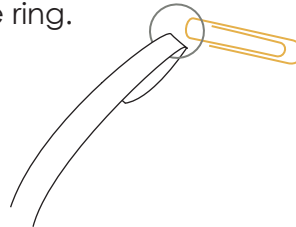

Step 2. make sure to pull the strings through according to how you want the curtains to hang on your bed.

See suggestion on the next page for how to pull the strings.

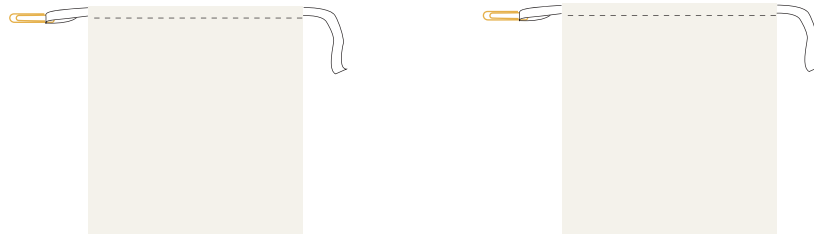

Step 3: pull the strings through the curtains.

BED A:

1. Use the long string to pull through the two printed curtains for the front.
2. Use one of the short strings to pull through each of the two side curtains.

Follow arrows in black.

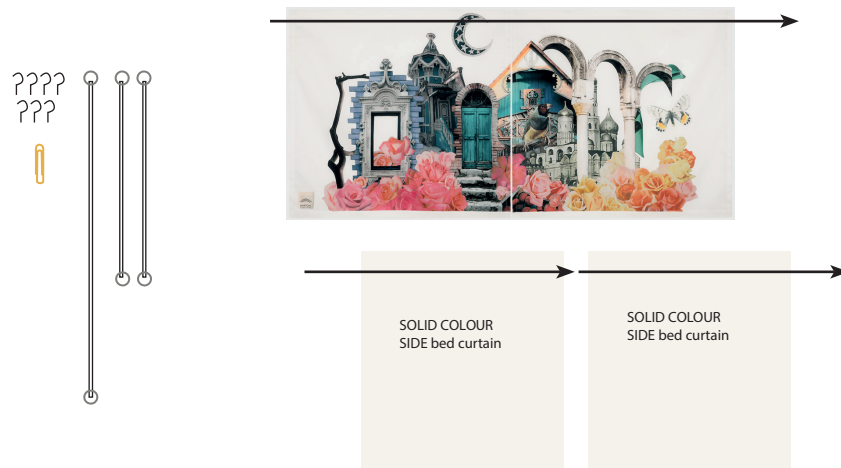

Step 3: pull the strings through the curtains.

BED A1: for beds with free sides ex. for Mid-High beds length 200 cm.

- 1. Use the long string to pull through the two printed curtains for the front.
- 2. Use one of the short strings to pull through each of the two side curtains.

Note: if you want a full coverage on the sides, place the bed against a corner and use both side curtains on one side. See Opt B1.

Follow arrows in black.

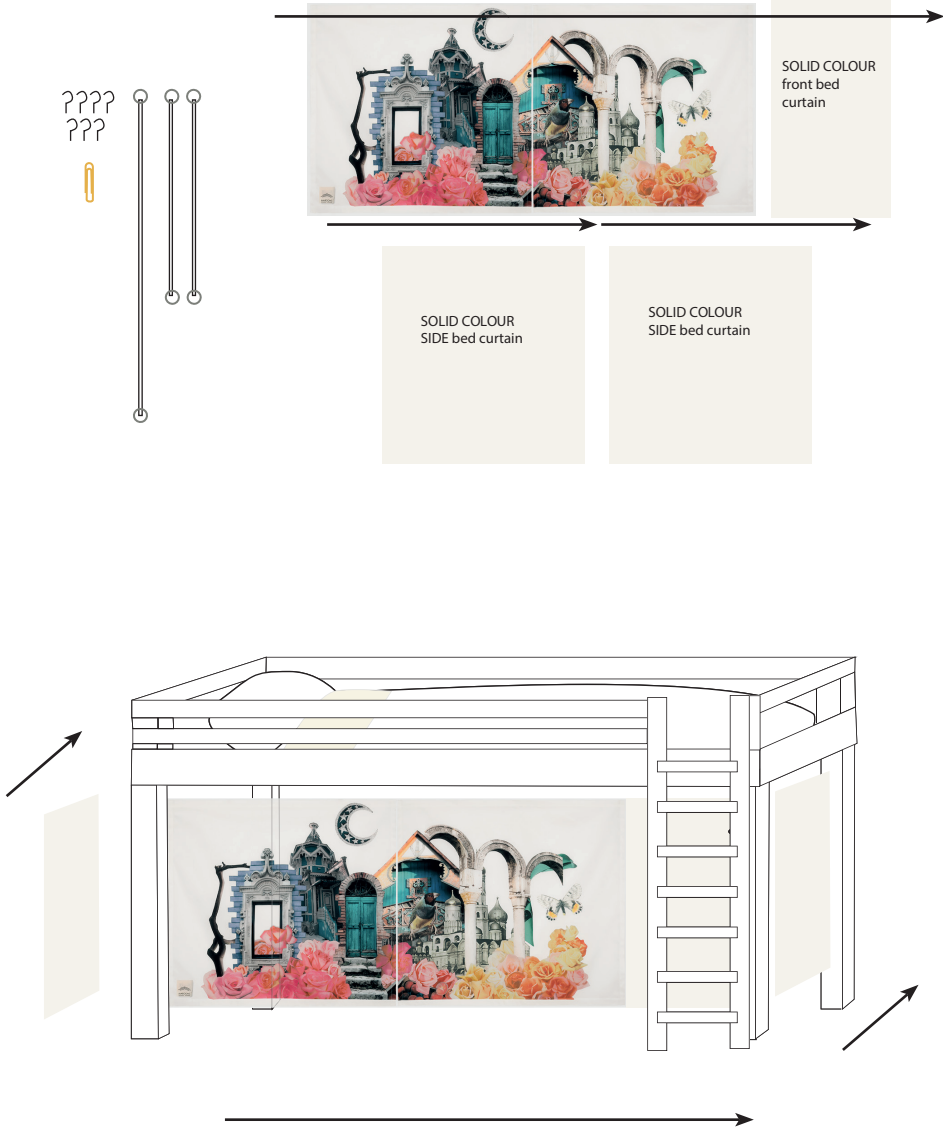

Step 3: pull the strings through the curtains.

BED A2: for beds placed in a corner ex. for Mid High beds length 200.

1. Use the long string to pull through the two printed curtains for the front.
2. Use one of the short strings to pull through both side curtains.

See arrow in black.

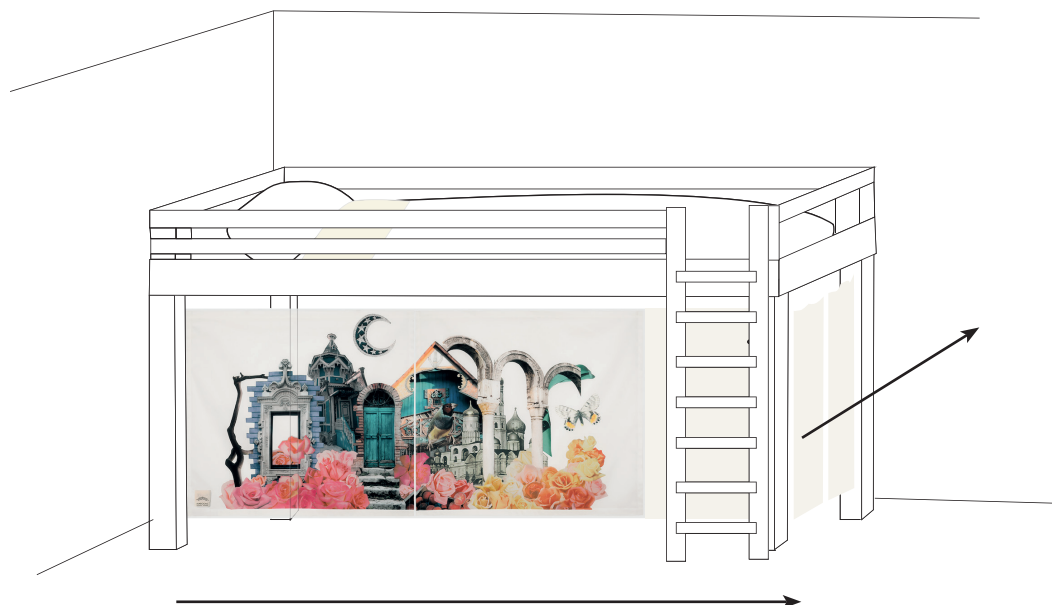
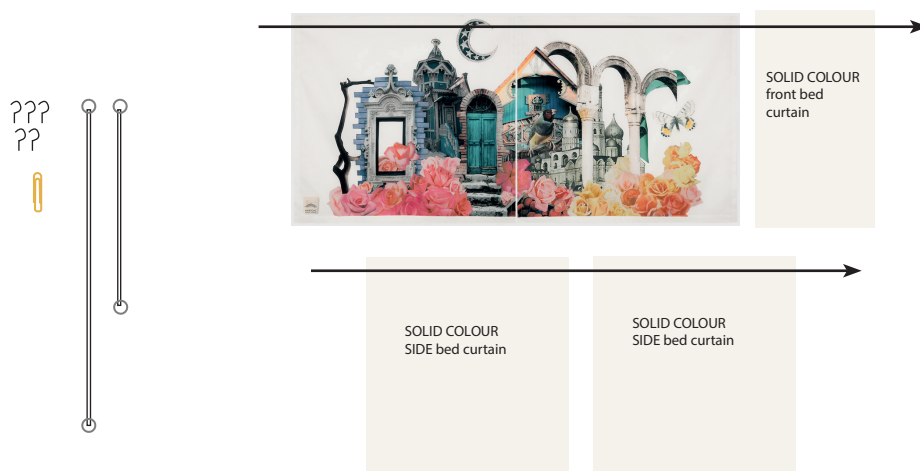

Step 4. It is now time to screw the hooks into the bed.

To make it easier for screwing the cup screws into the wooden bunk bed, an awl and a hammer is recommended to make the initial holes for the metal hooks.

Screw in the hooks by the legs first.

Follow RED arrows in next illustrations for your type of bed.

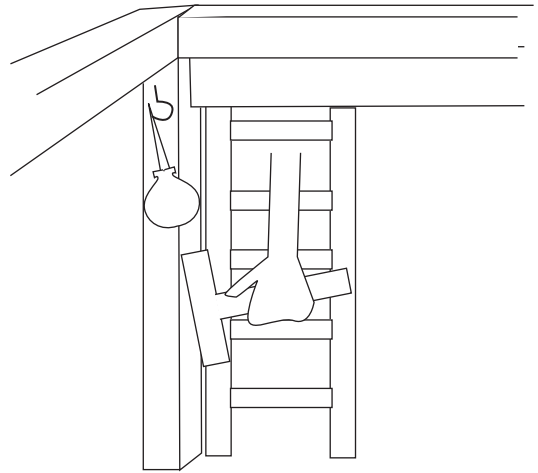

Screw in the center hook which supports the front curtains straight. This should be done 80 cm. Follow BLUE arrow in next illustration for your type of bed.

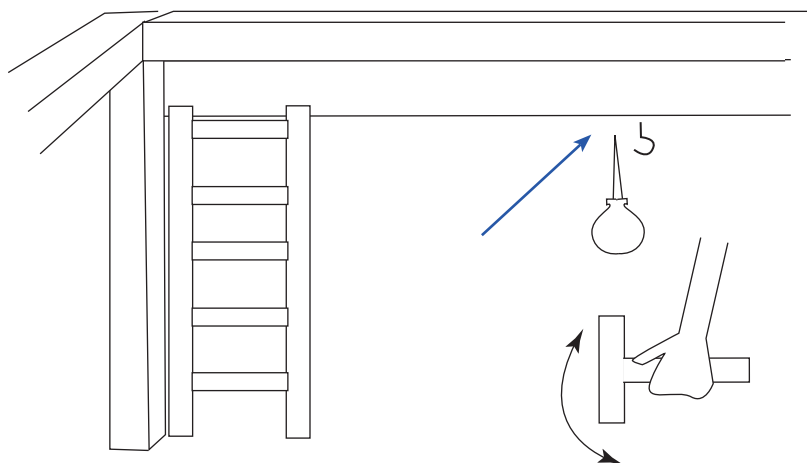

For Bed A:

Screw 7 hooks into the wooden bed as shown with red arrows below.

If the ladder is placed on the opposite site, the center hook should be placed 80 cm from the other side.

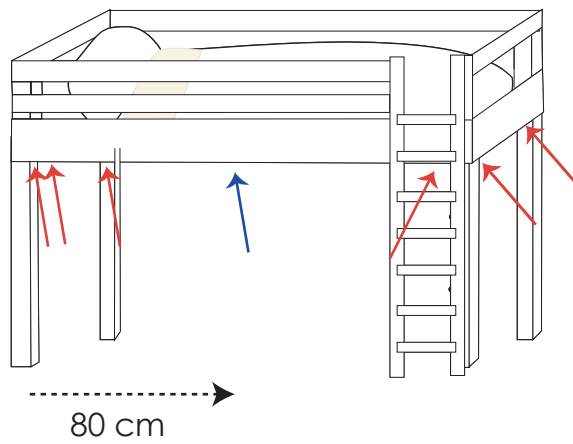

Step 5: each string is equipped with a metal ring. Put the ring on the hooks.

Step 6: tighten the straps on all sides with the regular.

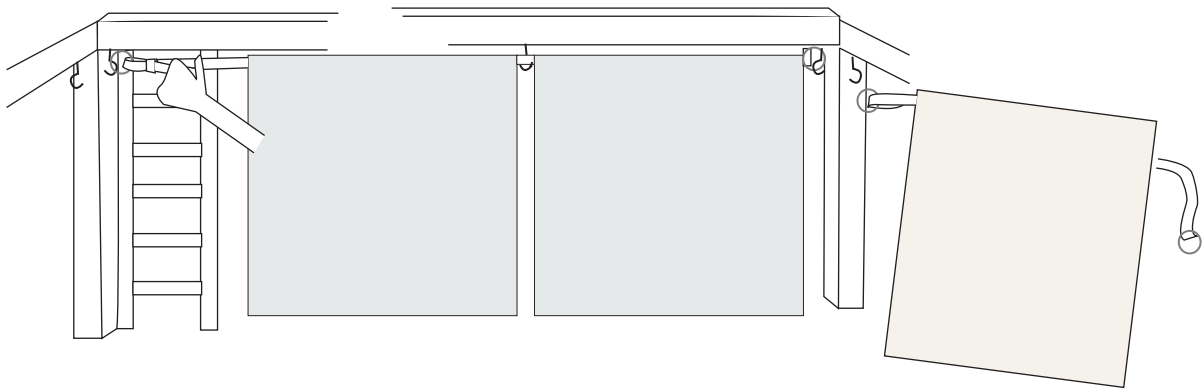

BED A1: for beds placed in a corner ex. for Mid High beds length 200.
Screw 7 hooks into the wooden bed as shown with red arrows below.
If the ladder is placed on the opposite site, the center hook should be placed 80 cm from the other side.

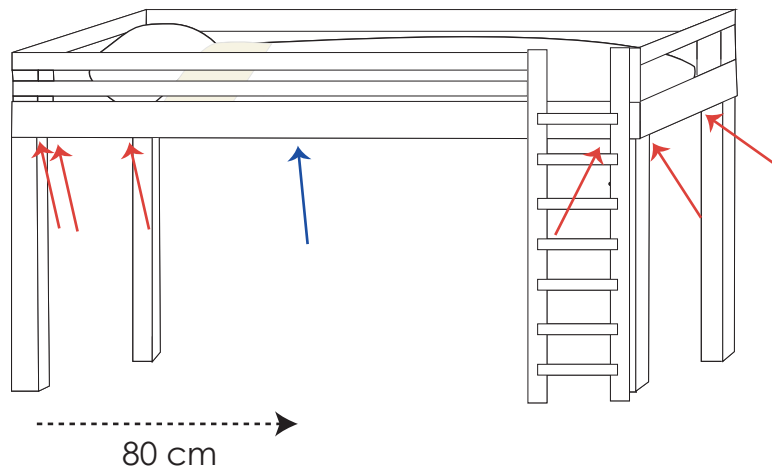

Step 5: each string is equipped with a metal ring. Put the ring on the hooks.

Step 6: tighten the straps on all sides with the regular.

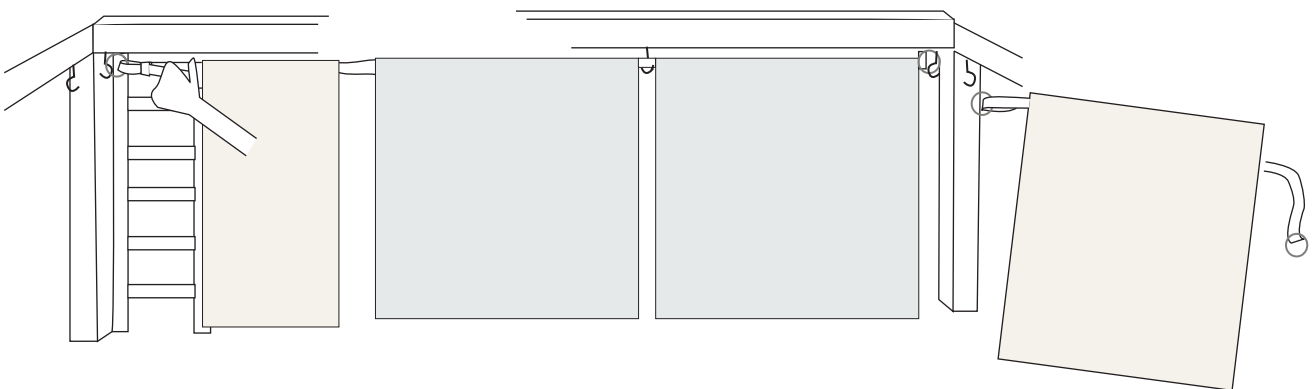

BED A2: for beds with free sides ex. for Mid-High beds length 200 cm.

Screw 5 hooks into the wooden bed as shown with red arrows below.

If the ladder is placed on the opposite site, the center hook should be placed 80 cm from the other side.

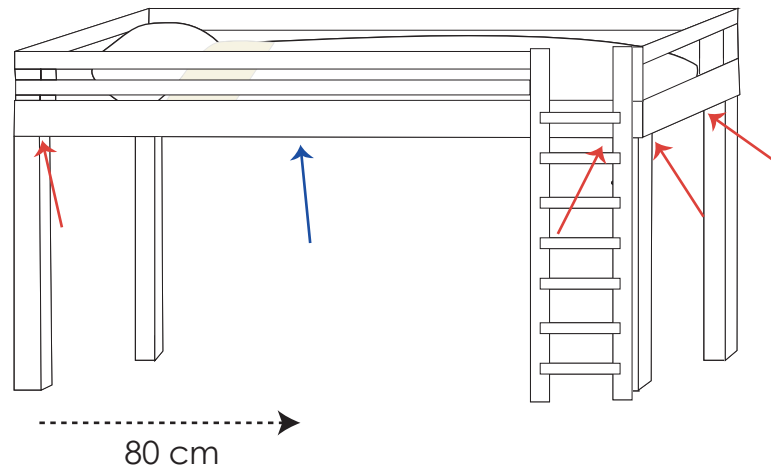

Step 5: each string is equipped with a metal ring. Put the ring on the hooks.

Step 6: tighten the straps on all sides with the regular.

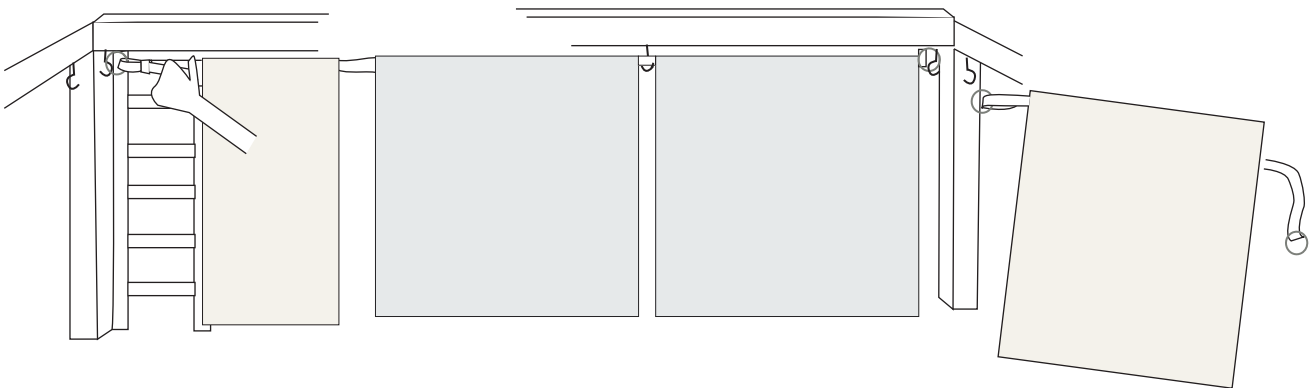

Maintenance:

if the curtains start to hang more loose, simply tighten the straps to make them hang nicely again.

WASH:

Pull out the strings before wash.

Wash at 30 degrees gentle wash.

Iron well to get a nice look.